

MCA2X 16 LED Controller

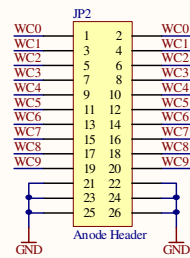

MCA2X 16 LED Controller

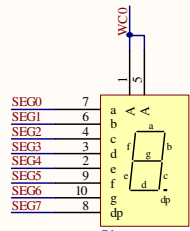

Q1 SA15-11

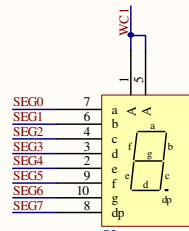

Q2 SA15-11

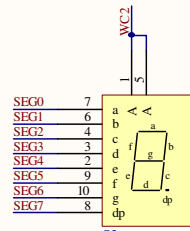

Q3 SA15-11

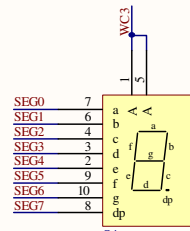

Q4 SA15-11

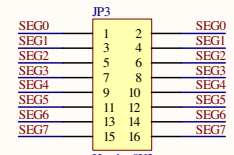

Header 8X2

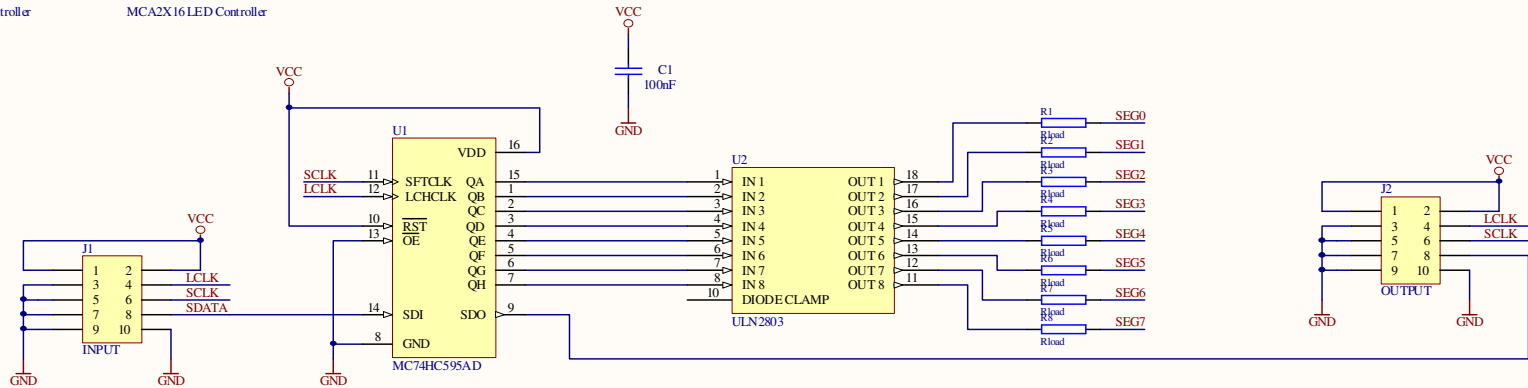

U1 MC74HC595AD

U2 ULN2803

C1 100nF

J2 OUTPUT